

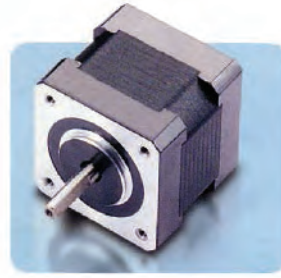

MPK系列二相步進馬達為HANMARK品牌標準產品，搭配HANMARK步進驅動器更能展現良好之性能。



# 17

## MPK系列二相步進馬達規格

馬達編號	馬達編號		步進角 Deg	電壓 V/Phase	電流 A/Phase	握持扭矩 gf·cm	阻抗 Ω/Phase	感抗 mH/Phase	轉子慣量 g·cm <sup>2</sup>	重量 g
	單軸	雙軸								
<b>42mm</b> 	MPK243-0.9A-□P	MPK243-0.9B-□P	1.8	4.0	0.95	1600	4.2	2.5	35	200
	MPK243-0.4A-□P	MPK243-0.4B-□P	1.8	9.6	0.4	1600	24	15	35	200
	MPK243-0.3A-□P	MPK243-0.3B-□P	1.8	12	0.31	1600	38.5	23	35	200
	MPK244-1.2A-□P	MPK244-1.2B-□P	1.8	4.0	1.2	2600	3.3	3.2	53	250
	MPK244-0.8A-□P	MPK244-0.8B-□P	1.8	6.0	0.8	2600	7.5	7.0	53	250
	MPK244-0.4A-□P	MPK244-0.4B-□P	1.8	12	0.4	2600	30	28	53	250
	MPK244-0.2A-□P	MPK244-0.2B-□P	1.8	24	0.2	2600	120	112	53	250
	MPK245-1.2A-□P	MPK245-1.2B-□P	1.8	4.2	1.2	3200	3.5	3	68	350
	MPK245-0.8A-□P	MPK245-0.8B-□P	1.8	6.0	0.8	3200	7.5	7.0	68	350
	MPK245-0.4A-□P	MPK245-0.4B-□P	1.8	12	0.4	3200	30	28	68	350

※出線方式(□P)標註於馬達編號後方，(4線式=4P、6線式=6P、8線式=8P)  
(例：MPK243-0.9A 出線方式為6線式，則馬達編號為 MPK243-0.9A-6P)

# 23

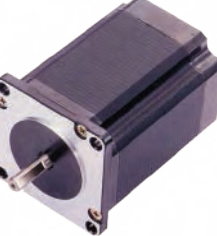
馬達編號	馬達編號		步進角 Deg	電壓 V/Phase	電流 A/Phase	握持扭矩 gf·cm	阻抗 Ω/Phase	感抗 mH/Phase	轉子慣量 g·cm <sup>2</sup>	重量 g
	單軸	雙軸								
<b>56mm</b> 	MPK264-1.0A-□P	MPK264-1.0B-□P	1.8	6	1.0	3900	6	5.6	120	470
	MPK264-2.0A-□P	MPK264-2.0B-□P	1.8	2.8	2.0	3900	1.4	1.3	120	470
	MPK264-3.0A-□P	MPK264-3.0B-□P	1.8	1.9	3.0	4100	0.63	0.6	120	470
	MPK266-1.0A-□P	MPK266-1.0B-□P	1.8	7.4	1.0	8500	7.4	15	280	700
	MPK266-2.0A-□P	MPK266-2.0B-□P	1.8	3.7	2.0	9000	1.85	3.2	300	700
	MPK266-3.0A-□P	MPK266-3.0B-□P	1.8	3.7	3.0	9000	0.75	1.15	300	700
	MPK268-1.0A-□P	MPK268-1.0B-□P	1.8	8.6	1.0	13500	8.6	16.2	480	1000
	MPK268-2.0A-□P	MPK268-2.0B-□P	1.8	4.8	2.0	13000	2.4	4.5	480	1000
	MPK268-3.0A-□P	MPK268-3.0B-□P	1.8	3.0	3.0	13000	1.0	2	480	1000

※出線方式(□P)標註於馬達編號後方，(4線式=4P、6線式=6P、8線式=8P)  
(例：MPK264-1.0A 出線方式為4線式，則馬達編號為 MPK264-1.0A-4P)

# 34

馬達編號	馬達編號		步進角 Deg	電壓 V/Phase	電流 A/Phase	握持扭矩 gf·cm	阻抗 Ω/Phase	感抗 mH/Phase	轉子慣量 g·cm <sup>2</sup>	重量 g
	單軸	雙軸								
<b>86mm</b> 	MPK296-2.0A-□P	MPK296-2.0B-□P	1.8	4.9	2.0	22000	2.45	6.9	1400	1750
	MPK296-3.0A-□P	MPK296-3.0B-□P	1.8	3.0	3.0	22000	1.0	4.0	1400	1750
	MPK296-4.5A-□P	MPK296-4.5B-□P	1.8	2.0	4.5	22000	0.45	1.9	1400	1750
	MPK299-2.0A-□P	MPK299-2.0B-□P	1.8	6.4	2.0	44000	3.2	20	2700	2800
	MPK299-3.0A-□P	MPK299-3.0B-□P	1.8	4.9	3.0	44000	1.65	7	2700	2800
	MPK299-4.5A-□P	MPK299-4.5B-□P	1.8	2.8	4.5	42000	0.66	3.0	2700	2800
	MPK2913-2.0A-□P	MPK2913-2.0B-□P	1.8	9.4	2.0	66000	4.7	23	4000	3930
	MPK2913-4.0A-□P	MPK2913-4.0B-□P	1.8	1.9	4.0	93000	0.48	4.5	4000	3930

※出線方式(□P)標註於馬達編號後方，(4線式=4P、6線式=6P、8線式=8P)  
(例：MPK296-2.0A 出線方式為6線式，則馬達編號為 MPK296-2.0A-6P)

# Model 17



## 規格表

馬達編號		步進角 Deg	電壓 V/Phase	電流 A/Phase	握持扭矩 gf·cm	阻抗 Ω/Phase	感抗 mH/Phase	轉子慣量 g·cm <sup>2</sup>	重量 g
單軸	雙軸								
MPK243-0.9A-□P	MPK243-0.9B-□P	1.8	4.0	0.95	1600	4.2	2.5	35	200
MPK243-0.4A-□P	MPK243-0.4B-□P	1.8	9.6	0.4	1600	24	15	35	200
MPK243-0.3A-□P	MPK243-0.3B-□P	1.8	12	0.31	1600	38.5	23	35	200
MPK244-1.2A-□P	MPK244-1.2B-□P	1.8	4.0	1.2	2600	3.3	3.2	53	250
MPK244-0.8A-□P	MPK244-0.8B-□P	1.8	6.0	0.8	2600	7.5	7.0	53	250
MPK244-0.4A-□P	MPK244-0.4B-□P	1.8	12	0.4	2600	30	28	53	250
MPK244-0.2A-□P	MPK244-0.2B-□P	1.8	24	0.2	2600	120	112	53	250
MPK245-1.2A-□P	MPK245-1.2B-□P	1.8	4.2	1.2	3200	3.5	3	68	350
MPK245-0.8A-□P	MPK245-0.8B-□P	1.8	6.0	0.8	3200	7.5	7.0	68	350
MPK245-0.4A-□P	MPK245-0.4B-□P	1.8	12	0.4	3200	30	28	68	350

※出線方式(□P)標註於馬達編號後方，(4線式=4P、6線式=6P、8線式=8P)  
 (例：MPK243-0.9A 出線方式為6線式，則馬達編號為 MPK243-0.9A-6P)

## 尺寸圖

Dimension (Unit: mm)

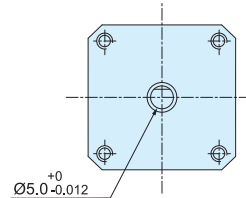
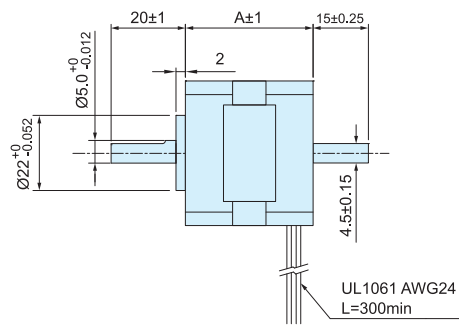
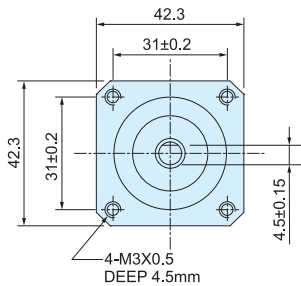

Type	Dim.	A
MPK243		33
MPK244		39
MPK245		47

## 出線線色、接線、驅動方式

### 四線式馬達 Wiring Diagram

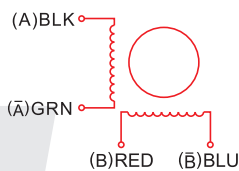

### 六線式馬達 Wiring Diagram

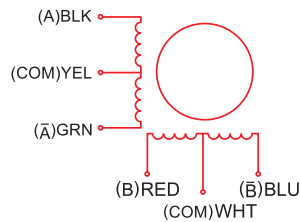

Unipolar  
兩相激磁

STEP	黑 Black A	紅 Red B	綠 Green A	藍 Blue B	COM	CCW
1	ON	ON				↑
2		ON	ON		+DCV	↓
3			ON	ON		↑
4	ON			ON		↓

### 八線式馬達 Wiring Diagram

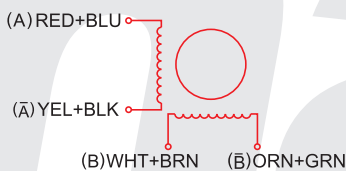

### 八線式馬達 Wiring Diagram

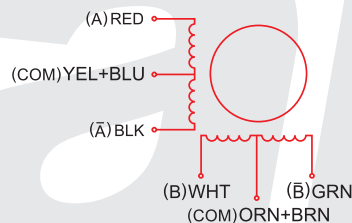

Unipolar  
兩相激磁

STEP	紅 Red 紅藍 Red Blue A	白 White 白棕 White Brown B	黑 Black 黃黑 Yellow Black A	綠 Green 橙綠 Orange Green B	COM	CCW
1	ON	ON				↑
2		ON	ON		+DCV	↓
3			ON	ON		↑
4	ON			ON		↓

# Model 23

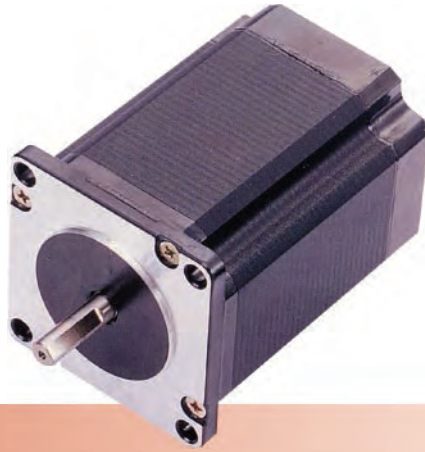

## 規格表

馬達編號		步進角 Deg	電壓 V/Phase	電流 A/Phase	握持扭矩 gf·cm	阻抗 Ω/Phase	感抗 mH/Phase	轉子慣量 g·cm <sup>2</sup>	重量 g
單軸	雙軸								
MPK264-1.0A-□P	MPK264-1.0B-□P	1.8	6	1.0	3900	6	5.6	120	470
MPK264-2.0A-□P	MPK264-2.0B-□P	1.8	2.8	2.0	3900	1.4	1.3	120	470
MPK264-3.0A-□P	MPK264-3.0B-□P	1.8	1.9	3.0	4100	0.63	0.6	120	470
MPK266-1.0A-□P	MPK266-1.0B-□P	1.8	7.4	1.0	8500	7.4	15	280	700
MPK266-2.0A-□P	MPK266-2.0B-□P	1.8	3.7	2.0	9000	1.85	3.2	300	700
MPK266-3.0A-□P	MPK266-3.0B-□P	1.8	3.7	3.0	9000	0.75	1.15	300	700
MPK268-1.0A-□P	MPK268-1.0B-□P	1.8	8.6	1.0	13500	8.6	16.2	480	1000
MPK268-2.0A-□P	MPK268-2.0B-□P	1.8	4.8	2.0	13000	2.4	4.5	480	1000
MPK268-3.0A-□P	MPK268-3.0B-□P	1.8	3.0	3.0	13000	1.0	2	480	1000

※出線方式(-□P)標註於馬達編號後方，(4線式=4P、6線式=6P、8線式=8P)  
 (例：MPK264-1.0A 出線方式為4線式，則馬達編號為 MPK264-1.0A-4P)

## 尺寸圖

Dimension (Unit: mm)

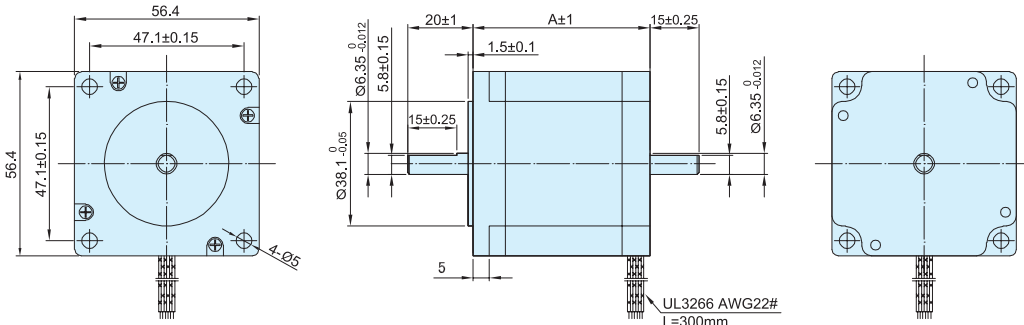

Type	Dim.	A
MPK264	41	
MPK266	54	
MPK268	76	

## 出線線色、接線、驅動方式

### 四線式馬達

#### Wiring Diagram

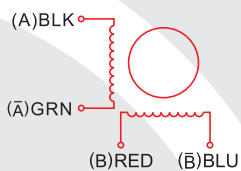

### 六線式馬達

#### Wiring Diagram

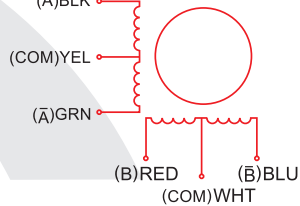

Unipolar  
兩相激磁

STEP	黑 Black A	紅 Red B	綠 Green A	藍 Blue B	COM	CCW
1	ON	ON			+DCV	↑
2		ON	ON			
3			ON	ON		
4	ON			ON		
						CW

### 八線式馬達

#### Wiring Diagram

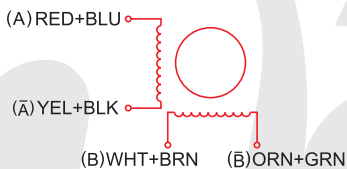

### 八線式馬達

#### Wiring Diagram

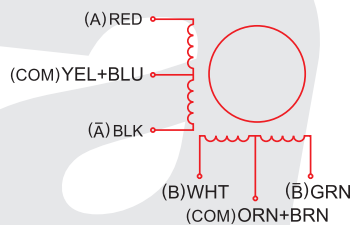

Unipolar  
兩相激磁

STEP	紅 Red A	白 White B	黑 Black A	綠 Green B	COM	CCW
1	ON	ON			+DCV	↑
2		ON	ON			
3			ON	ON		
4	ON			ON		
						CW

# Model 34



## 規格表

馬達編號		步進角 Deg	電壓 V/Phase	電流 A/Phase	握持扭距 gf·cm	阻抗 Ω/Phase	感抗 mH/Phase	轉子慣量 g·cm <sup>2</sup>	重量 g
單軸	雙軸								
MPK296-2.0A-□P	MPK296-2.0B-□P	1.8	4.9	2.0	22000	2.45	6.9	1400	1750
MPK296-3.0A-□P	MPK296-3.0B-□P	1.8	3.0	3.0	22000	1.0	4.0	1400	1750
MPK296-4.5A-□P	MPK296-4.5B-□P	1.8	2.0	4.5	22000	0.45	1.9	1400	1750
MPK299-2.0A-□P	MPK299-2.0B-□P	1.8	6.4	2.0	44000	3.2	20	2700	2800
MPK299-3.0A-□P	MPK299-3.0B-□P	1.8	4.9	3.0	44000	1.65	7	2700	2800
MPK299-4.5A-□P	MPK299-4.5B-□P	1.8	2.8	4.5	42000	0.66	3.0	2700	2800
MPK2913-2.0A-□P	MPK2913-2.0B-□P	1.8	9.4	2.0	66000	4.7	23	4000	3930
MPK2913-4.0A-□P	MPK2913-4.0B-□P	1.8	1.9	4.0	93000	0.48	4.5	4000	3930

※出線方式(□P)標註於馬達編號後方，(4線式=4P、6線式=6P、8線式=8P)  
 (例：MPK296-2.0A 出線方式為6線式，則馬達編號為 MPK296-2.0A-6P)

## 尺寸圖

Dimension (Unit: mm)

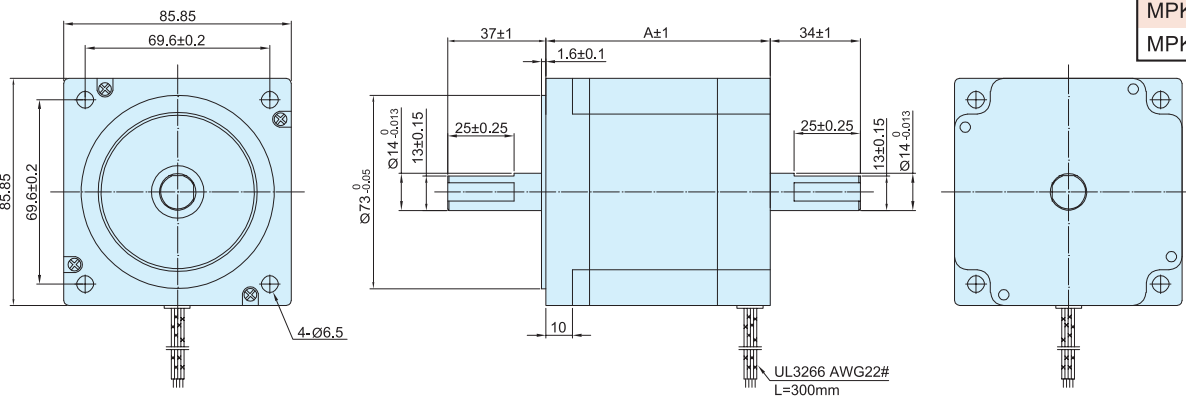

Type	Dim.	A
MPK296		66
MPK299		98
MPK2913		126

## 出線線色、接線、驅動方式

### 四線式馬達

#### Wiring Diagram

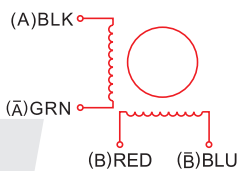

### 六線式馬達

#### Wiring Diagram

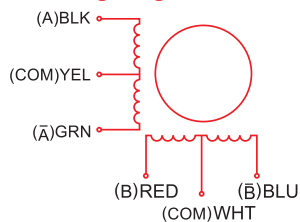

Unipolar  
兩相激磁

STEP	黑 Black A	紅 Red B	綠 Green A	藍 Blue B	COM	CCW
1	ON	ON			+DCV	↑
2		ON	ON			
3			ON	ON		
4	ON			ON		

### 八線式馬達

#### Wiring Diagram

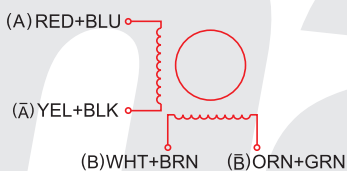

### 八線式馬達

#### Wiring Diagram

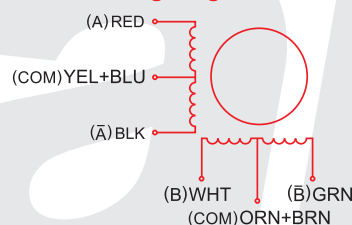

Unipolar  
兩相激磁

STEP	紅 Red A	白 White B	黑 Black A	綠 Green B	COM	CCW
1	ON	ON			+DCV	↑
2		ON	ON			
3			ON	ON		
4	ON			ON		